

LumiCloud™ 3D - ASTRA

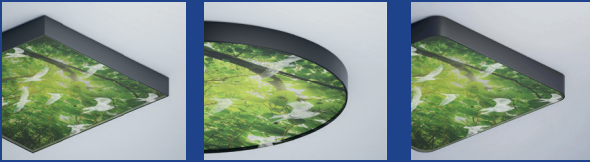

Spécifié par: _____

Agence : _____

Nom du projet : _____

Type de projet : _____

Notes: _____



PERFORMANCE D'ÉCLAIRAGE*

CARRA	Flux lumineux	Type		
		8' x 4'	10' x 6'	12' x 8'
Consommation électrique (Watts)	Premium	252W	490W	798W
Flux lumineux délivré (Lumens)	Standard	126W	245W	399W

CIRCA	Flux lumineux	Type				
		4ft	5ft	6ft	8ft	10ft
Consommation électrique (Watts)	Premium	92.4W	156.8W	217W	414.4W	664.3W
Flux lumineux délivré (Lumens)	Standard	47.6W	70W	114.8W	212.8W	336.7W

*La consommation électrique est basée sur la source LED (6500K)

CODE DE COMMANDE

TLS	LC3D		AS		Indice d'utilisation	Dimensions				Structure		Type de montage						
	Produit	Modèle	Module lumineux															
TLS	LumiCloud 3D	LC3D	Carra	CR	Astra	AS	Intérieur	IN	8'x4'	8x4	4'	4	À coins carrés	SQ	Encastré	RD		
			Circa	CI					Extérieur	OUT	10'x6'	10x6	5	5	À coins arrondis	RO	En surface	SF
											12'x8'	12x8	6'	6	N/A*	NA	Suspendu	SP
											8'	8					T-bar ¹	TB
											10'	10					Mur en surface	WLS
																	Mur encastré	WLR

* Pour Circa

¹ Non compatible avec les coins arrondis

Couleur de la structure	56K		Flux lumineux*	Commande	Diffuseur	3DMF	3D Désign*
	CCT						
Noir	BL	5600K	Premium (909 lm/pi ²) ²	0-10V	LightTex Media	3D Mesh Flex	* Consultez les inspirations 3D dans la section finale de la fiche technique ou dans le catalogue complet d'inspirations. Sélectionnez le design de votre choix et indiquez son code ici.
Blanc	WH		Standard (494 lm/pi ²)	Télécommande RF			
Argent	NS			Dali			



² Les lm/pi² sont calculés à la source LED

SPÉCIFICATIONS TECHNIQUES

■ Diffuseur

	LightTex Media	3D Mesh Flex
Composition	100 % Polyester	100 % Polyester
Poids	172 g/m ² (16 g/pi ²)	43g/m ² (4g/pi ²)
Classement au feu	NFPA-701, B1, EN 13501-1, B-s1, d0	NFPA-701, B1, EN 13501-1, B-s1, d0

■ Couleur de la structure

Matériau	Aluminium		
Couleurs standard	Noir 	Blanc 	Argent 

Des couleurs personnalisées sont offertes.

■ Système d'éclairag

Indice de protection	IP65 - IP22 (intérieur)
CRI	~ 90 (white LED)
LM80 *	> 150,000 hours
Température de fonctionnement	-30 °C TO 80 °C

Remarque : Le test *LM80 s'applique uniquement aux LED blanches

Garantie*	Garantie limitée de 5 ans sur les LED
------------------	---------------------------------------

* Conditions complètes: www.tls-led.com/warranty

STRUCTURE

■ Sans cadre à coins carrés (SQ)

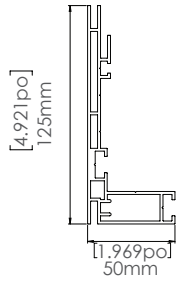

FLS 2125-V2

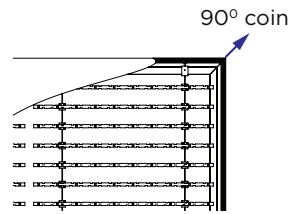

■ Sans cadre à coins arrondis (RO)

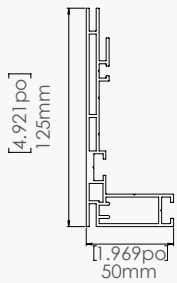

FLS 2125-V2

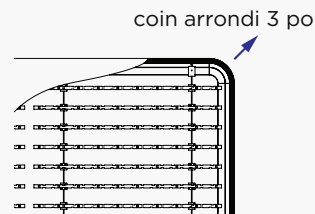

■ Circa

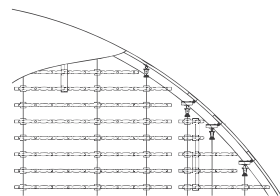
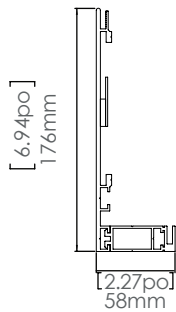

DIMENSIONS PREMIUM

8'x4'

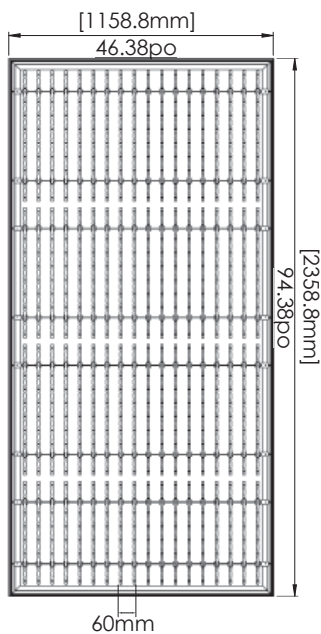

10'x6'

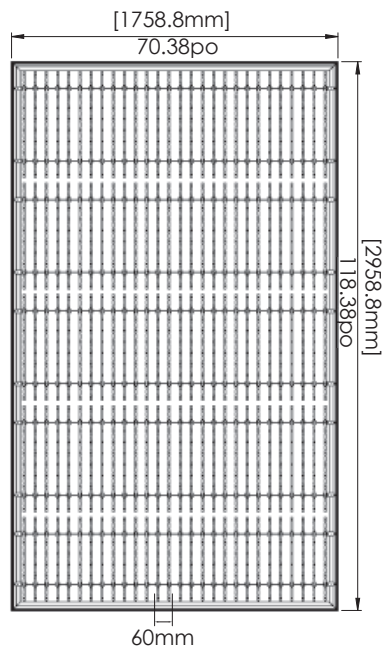

12'x8'

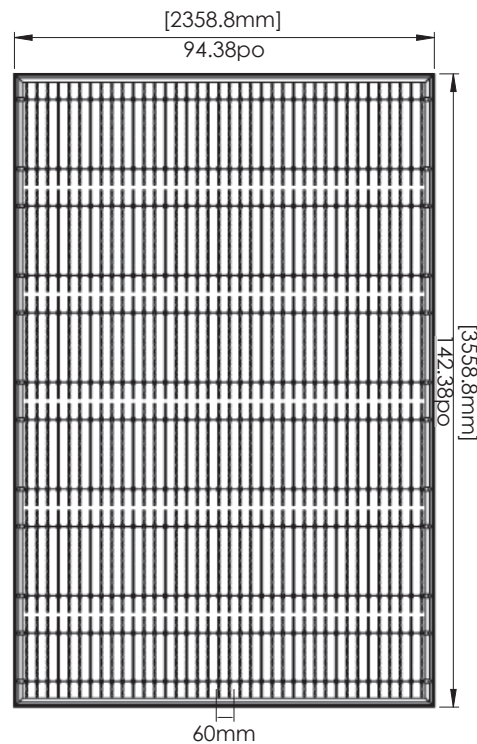

Remarque : des dimensions personnalisées sont disponibles avec le modèle LumiCloud™ Bespoke.

■ Carra Poids (coins carrés) (Premium)

Format	4'x8'	6'x10'	8'x12'
Kg	33.4	59.6	71.3
Lbs	73.7	131.4	157.1

■ Carra Poids (coins arrondi) (Premium)

Format	4'x8'	6'x10'	8'x12'
Kg	33.6	59.7	71.4
Lbs	74.0	131.7	157.4

Les variations peuvent exister mais ne doivent pas dépasser les valeurs indiquées.

DIMENSIONS PREMIUM

4ft

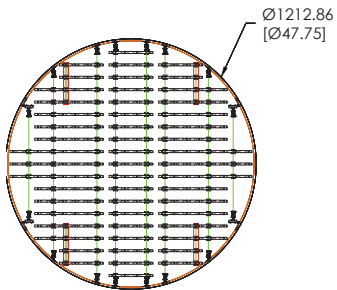

5ft

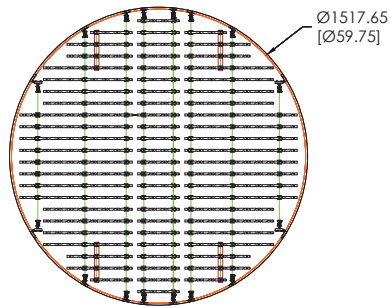

6ft

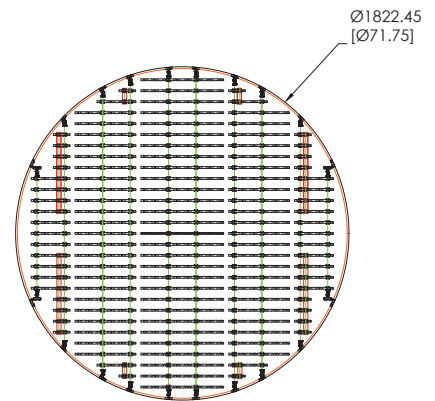

8ft

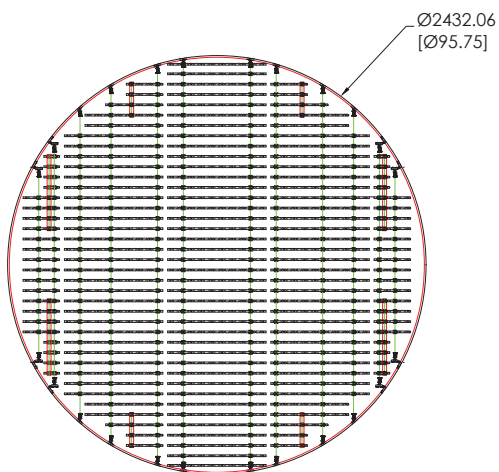

10ft

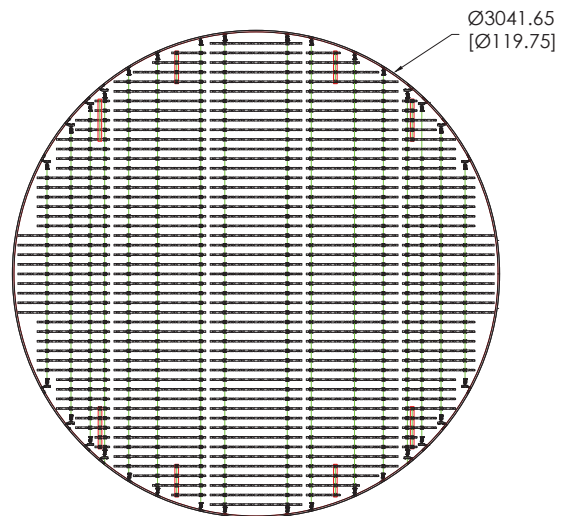

Remarque : des dimensions personnalisées sont disponibles avec le modèle LumiCloud™ Bespoke.

■ Circa Poids (Premium)

Format	4ft	5ft	6ft	8ft	10ft
Kg	26.8	32.1	38.3	54.4	76.2
Lbs	59.1	70.7	84.4	119.9	168.1

Les variations peuvent exister mais ne doivent pas dépasser les valeurs indiquées.

DIMENSIONS STANDARD

8'x4'

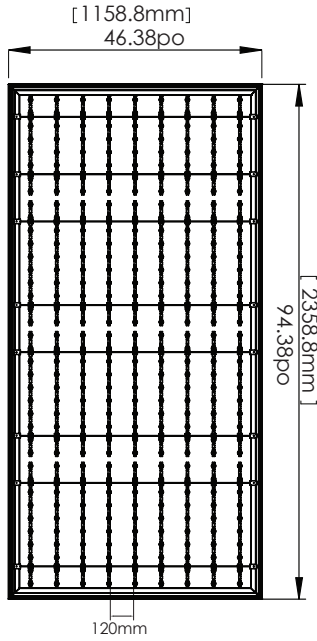

10'x6'

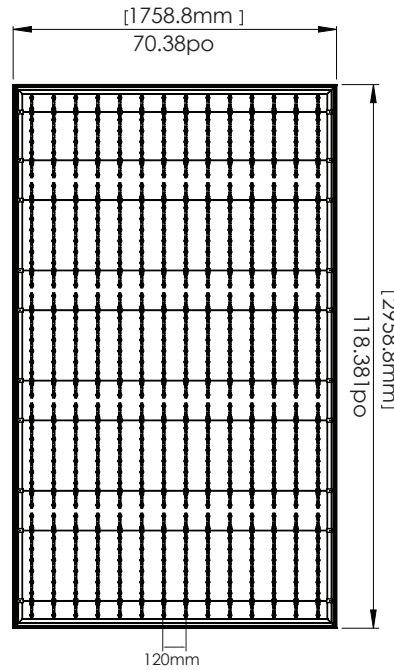

12'x8'

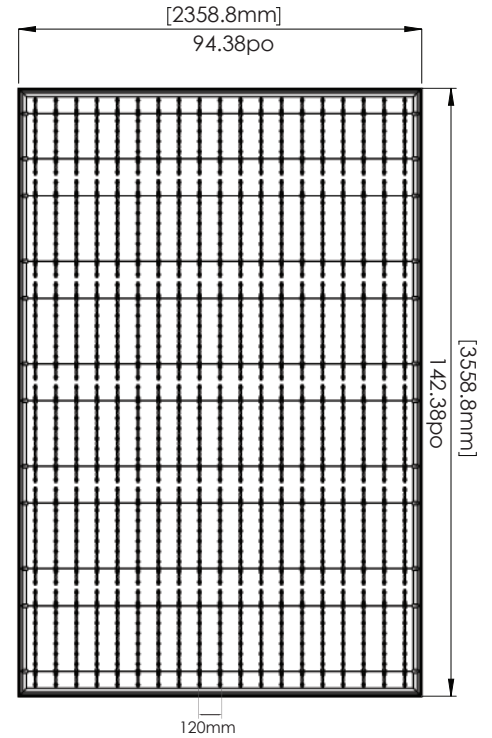

Remarque : des dimensions personnalisées sont disponibles avec le modèle LumiCloud™ Bespoke.

■ Carra Poids (coins carrés) (Standard)

Format	4'x8'	6'x10'	8'x12'
Kg	31.4	48.8	67.3
Lbs	69.2	107.5	148.3

■ Carra Poids (coins arrondi) (Standard)

Format	4'x8'	6'x10'	8'x12'
Kg	31.6	48.9	67.4
Lbs	69.6	107.9	148.6

Les variations peuvent exister mais ne doivent pas dépasser les valeurs indiquées.

DIMENSIONS STANDARD

4ft

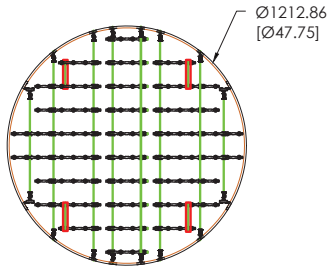

5ft

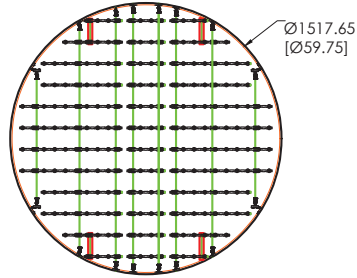

6ft

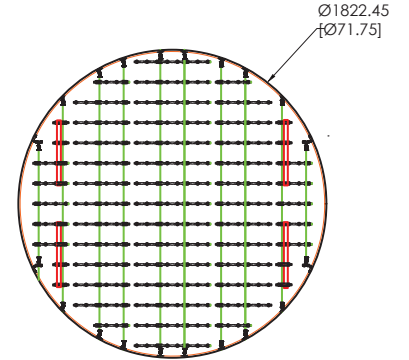

8ft

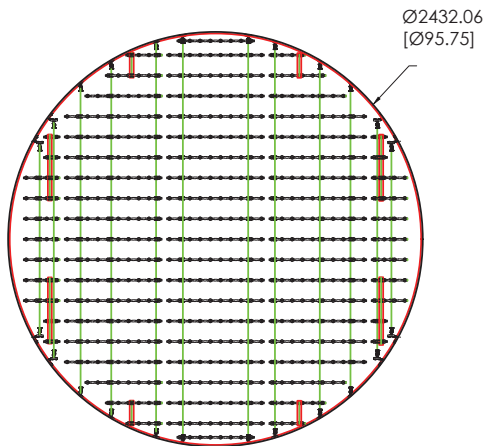

10ft

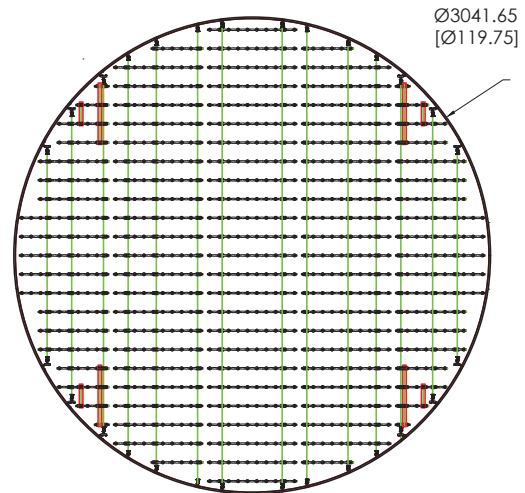

Remarque : des dimensions personnalisées sont disponibles avec le modèle LumiCloud™ Bespoke.

■ Circa Poids (Standard)

Format	4ft	5ft	6ft	8ft	10ft
Kg	26.3	31.4	37.1	50.2	67.9
Lbs	58.0	69.2	81.8	110.6	149.7

Les variations peuvent exister mais ne doivent pas dépasser les valeurs indiquées.

OPTIONS DE MONTAGE (CARRA PREMIUM ET STANDARD)

Encastré (RD)

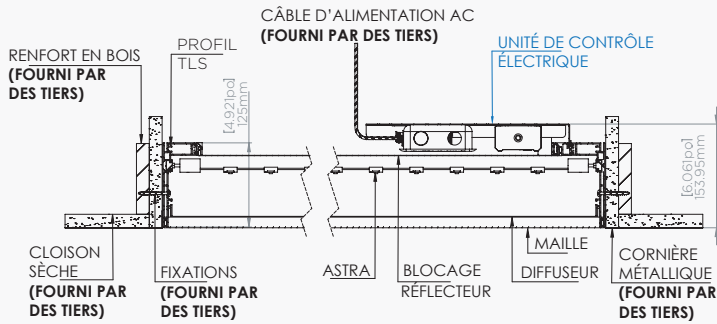

- Cavité : +3 mm (1/8") par rapport aux dimensions nominales
- Profondeur minimale de cavité : 177,8 mm (7")

En surface (SF)

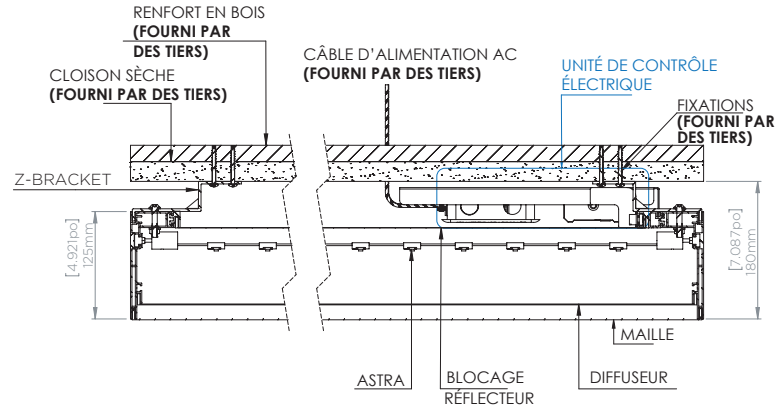

Suspendu (SP)

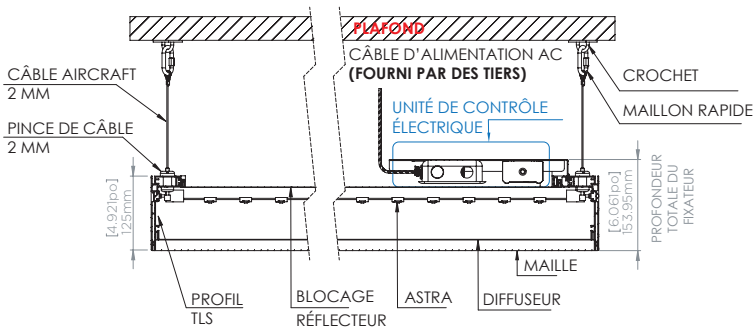

- Se fixe au plafond existant (fourni par des tiers)

T-bar (TB)

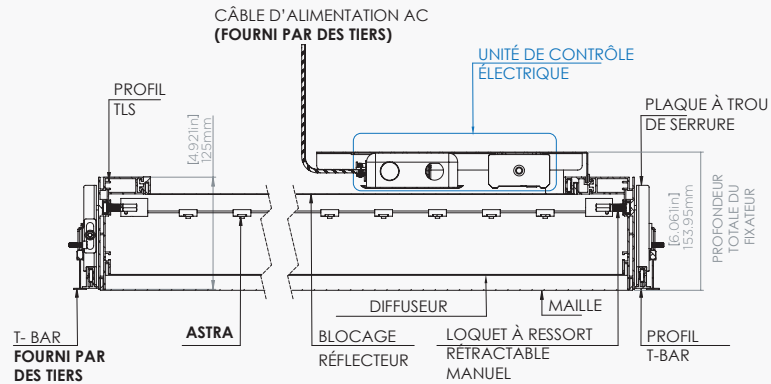

Note: Parts reference numbers are available upon request.

OPTIONS DE MONTAGE (CIRCA STANDARD)

■ Encastré (RD)

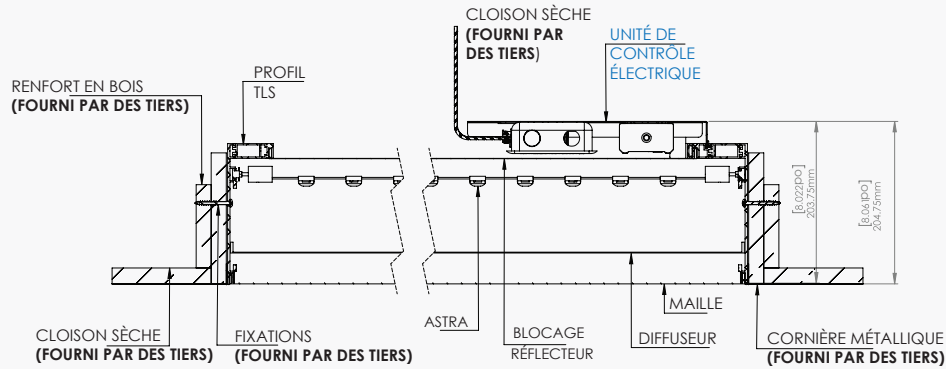

Cavité : +3 mm (1/8") par rapport aux dimensions nominales
Profondeur minimale de cavité : 177,8 mm (7")

■ En surface (SF)

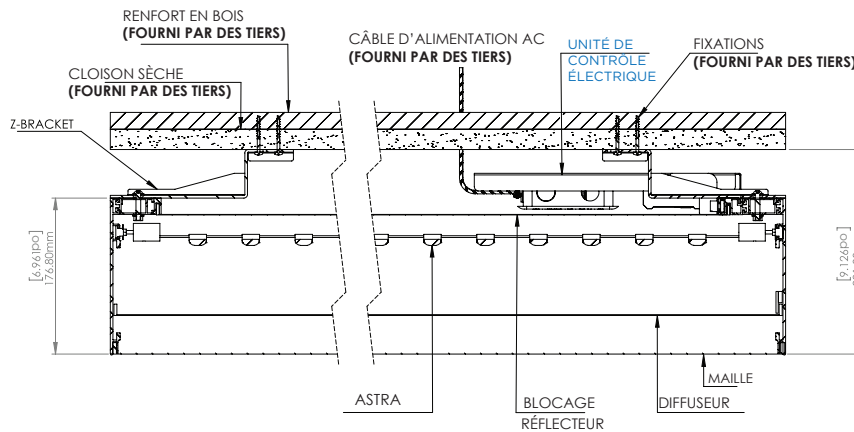

■ Suspendu (SP)

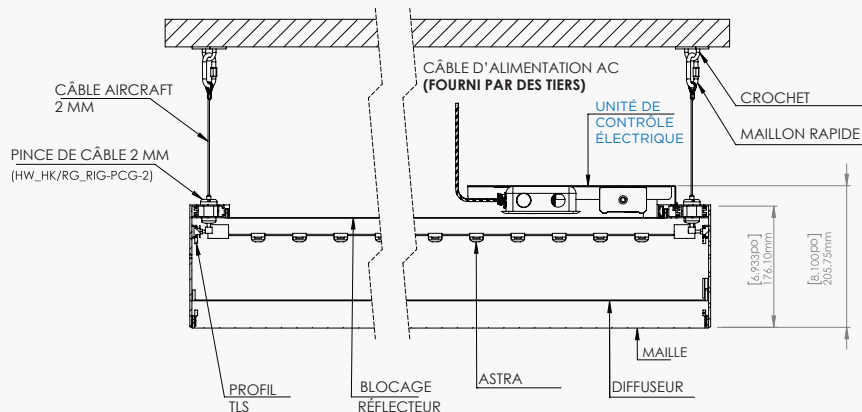

Se fixe au plafond existant (fourni par des tiers)

Remarque : Les numéros de référence des pièces sont disponibles sur demande.

COMMANDE

■ 0-10V (0/10)

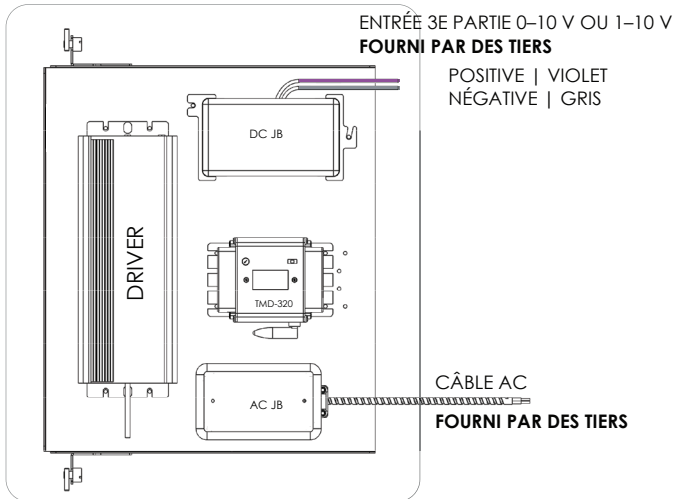

■ Télécommande RF (RM)

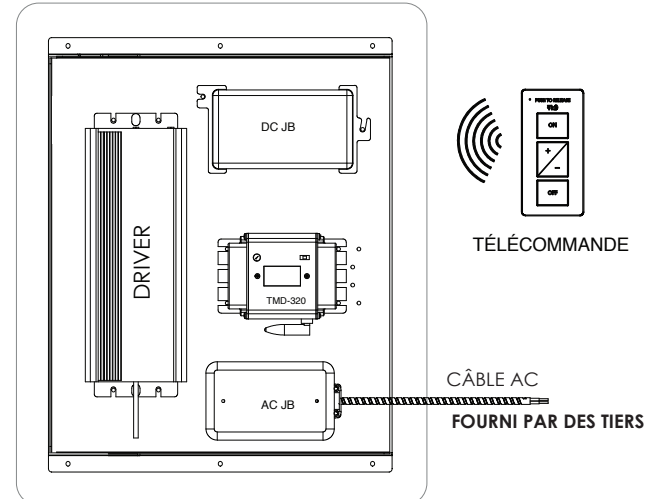

■ Dali (DA)

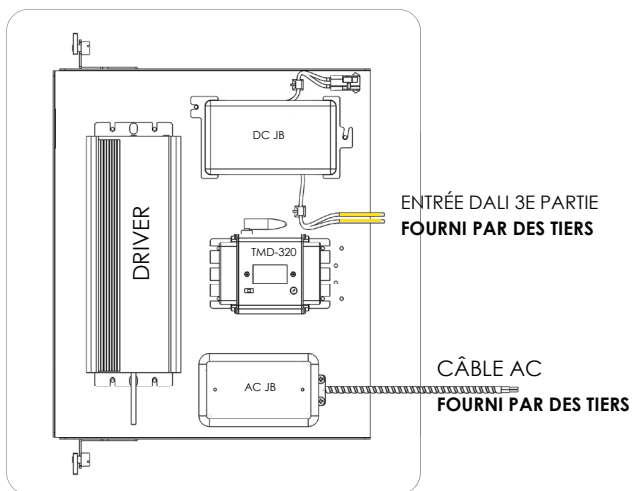

■ SYSTÈME ÉLECTRIQUE

Modèles de driver	HLG-60-24A, HLG-100-24A, HLG-150-24A, HLG-240-24A, HLG-320-24A
Tension d'entrée	90-305 V AC, 47-63 Hz
Tension de sortie	21-24 V DC

OPTIONS D'INSPIRATION 3D

■ Une lumière alliant profondeur, dimension et design

LumiCloud 3D propose une nouvelle façon de concevoir l'éclairage, où la lumière et les motifs se combinent pour créer un **effet visuel tridimensionnel saisissant**. Le résultat : un élément distinctif qui transforme les plafonds et les murs en surfaces dynamiques et vibrantes.



LA BANNIÈRE
ARRIÈRE

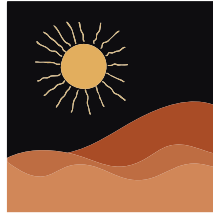

LA BANNIÈRE
FRONTALE EN MESH



LA BANNIÈRE ARRIÈRE +
BANNIÈRE MESH

■ La bannière arrière + la bannière mesh

- **La bannière arrière** (pleine) constitue l'arrière-plan de la scène.
- **La bannière frontale** en mesh ajoute des éléments semi-transparentes qui créent de la profondeur et du mouvement lorsqu'elle est observée sous différents angles.
- **La distance** entre les deux bannières amplifie l'effet 3D.

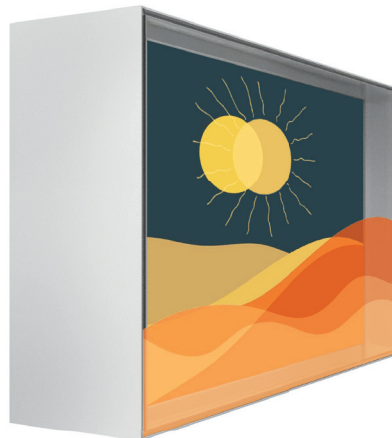

Choisissez parmi une gamme **de motifs visuels** soigneusement sélectionnés, conçus pour inspirer tous les environnements:

Distinctif. Immersif. Mémorable.

LumiCloud 3D transforme un éclairage ordinaire en **une expérience multidimensionnelle**.

OPTIONS D'INSPIRATION 3D

■ Plafond "Skyward Whisper"

Code: **CSW01**



LA BANNIÈRE
ARRIÈRE



LA BANNIÈRE
FRONTALE EN MESH



LA BANNIÈRE ARRIÈRE +
BANNIÈRE MESH

■ Plafond "Sakura Breeze"

Code: **CSB02**

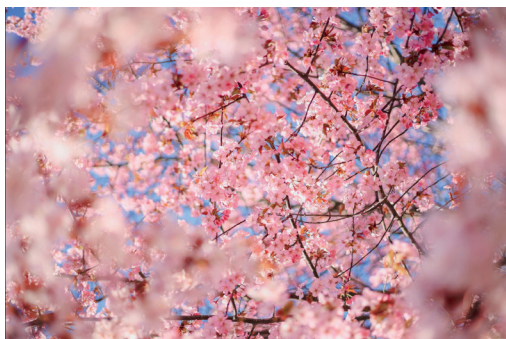

LA BANNIÈRE
ARRIÈRE

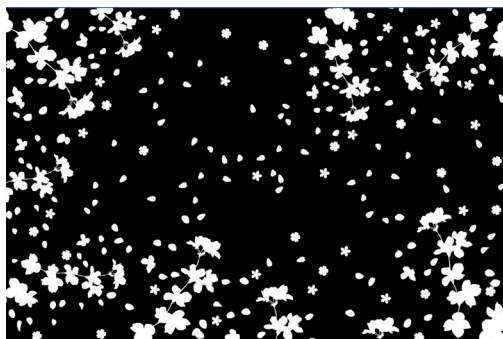

LA BANNIÈRE
FRONTALE EN MESH

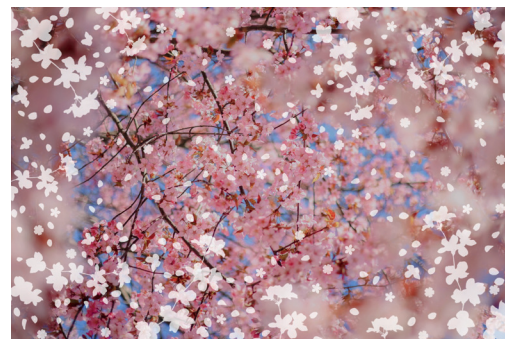

LA BANNIÈRE ARRIÈRE +
BANNIÈRE MESH

■ Plafond "The Falling Season"

Code: **CFS03**

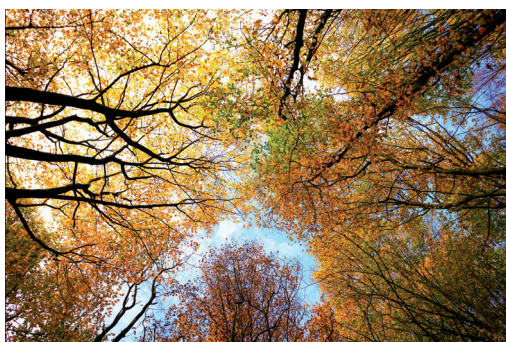

LA BANNIÈRE
ARRIÈRE



LA BANNIÈRE
FRONTALE EN MESH

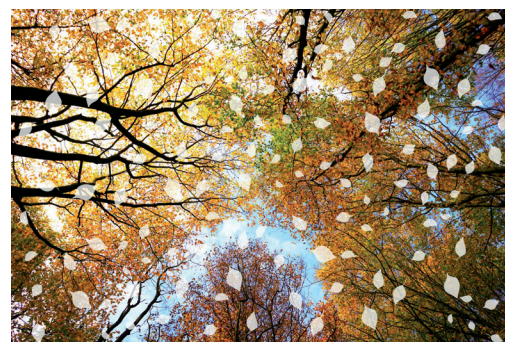

LA BANNIÈRE ARRIÈRE +
BANNIÈRE MESH

OPTIONS D'INSPIRATION 3D

■ Mur "Celestial Forest"

Code: **CCF04**



LA BANNIÈRE
ARRIÈRE



LA BANNIÈRE
FRONTALE EN MESH



LA BANNIÈRE ARRIÈRE +
BANNIÈRE MESH

■ Mur "Verdant Veil"

Code: **WVV05**



LA BANNIÈRE
ARRIÈRE



LA BANNIÈRE
FRONTALE EN MESH



LA BANNIÈRE ARRIÈRE +
BANNIÈRE MESH

■ Mur "Whispers of Spring"

Code: **WWS06**

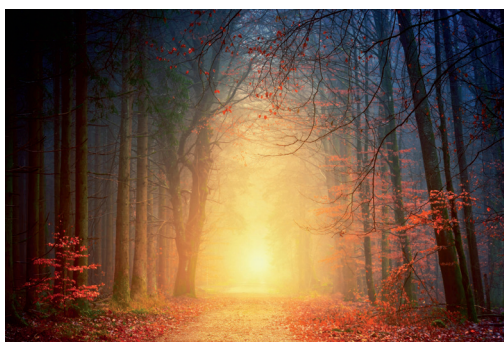

LA BANNIÈRE
ARRIÈRE



LA BANNIÈRE
FRONTALE EN MESH



LA BANNIÈRE ARRIÈRE +
BANNIÈRE MESH

OPTIONS D'INSPIRATION 3D

■ Plafond "Celestial Roots"

Code: **CCR07**

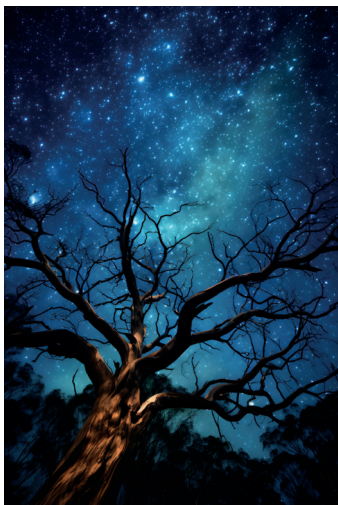

LA BANNIÈRE
ARRIÈRE



LA BANNIÈRE
FRONTALE EN MESH



LA BANNIÈRE ARRIÈRE +
BANNIÈRE MESH

■ Plafond "The Ember Sky"

Code: **CES08**

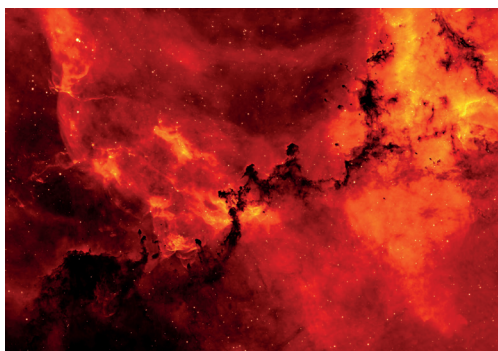

LA BANNIÈRE
ARRIÈRE

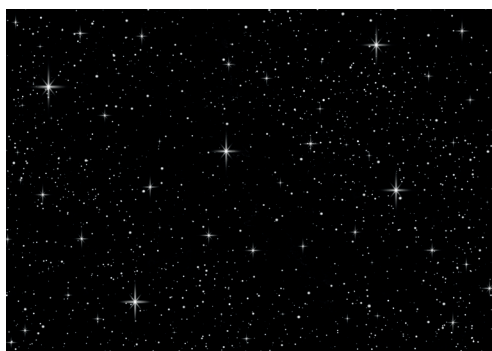

LA BANNIÈRE
FRONTALE EN MESH

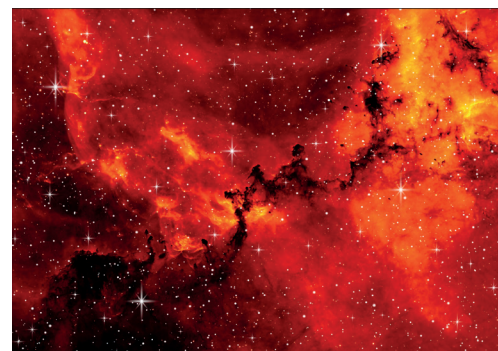

LA BANNIÈRE ARRIÈRE +
BANNIÈRE MESH

■ Plafond "Lunar Reverie"

Code: **CLR09**



LA BANNIÈRE
ARRIÈRE

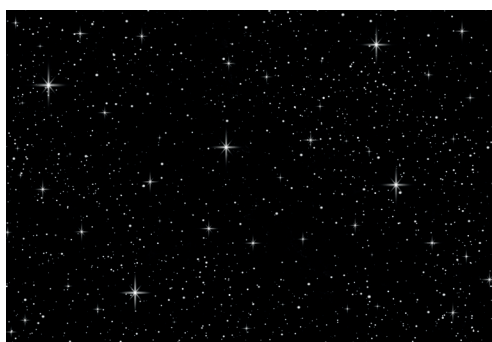

LA BANNIÈRE
FRONTALE EN MESH

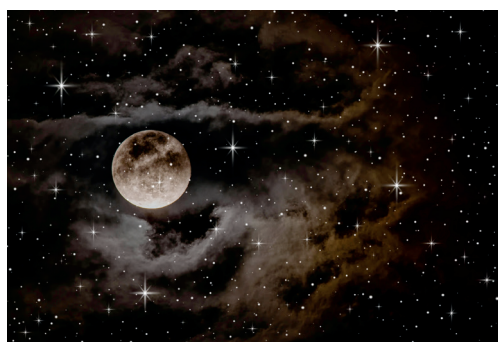

LA BANNIÈRE ARRIÈRE +
BANNIÈRE MESH

OPTIONS D'INSPIRATION 3D

■ Mur "Celestial Tide"

Code: **WCT10**



LA BANNIÈRE
ARRIÈRE



LA BANNIÈRE
FRONTALE EN MESH



LA BANNIÈRE ARRIÈRE +
BANNIÈRE MESH

■ Mur "Silent Constellations"

Code: **WSC11**



LA BANNIÈRE
ARRIÈRE

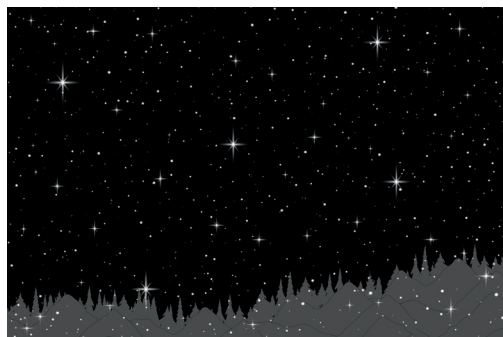

LA BANNIÈRE
FRONTALE EN MESH



LA BANNIÈRE ARRIÈRE +
BANNIÈRE MESH

■ Mur "Echoes of Midnight"

Code: **WEM12**

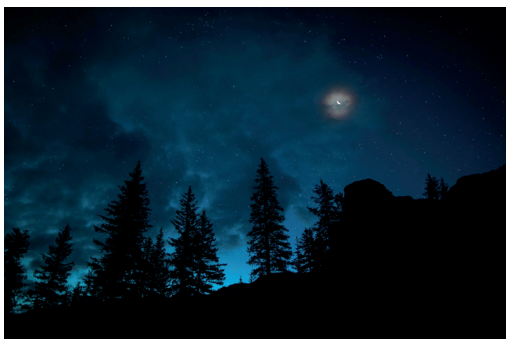

LA BANNIÈRE
ARRIÈRE

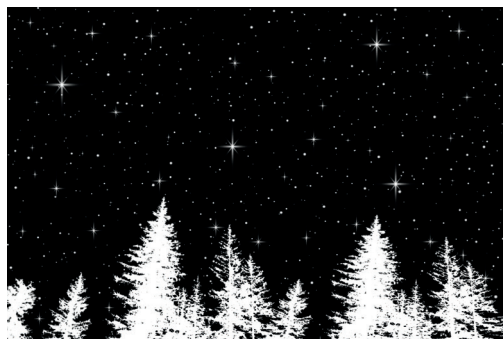

LA BANNIÈRE
FRONTALE EN MESH

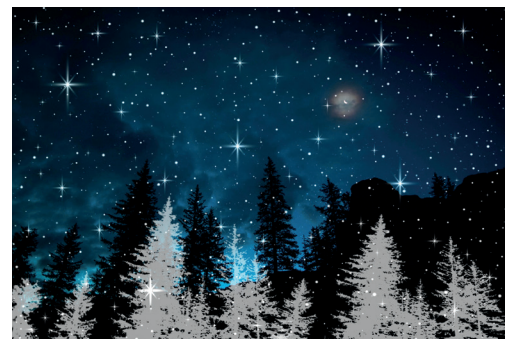

LA BANNIÈRE ARRIÈRE +
BANNIÈRE MESH

OPTIONS D'INSPIRATION 3D

- **Mur "Abyss of Light"**

Code: **WAL13**



LA BANNIÈRE
ARRIÈRE

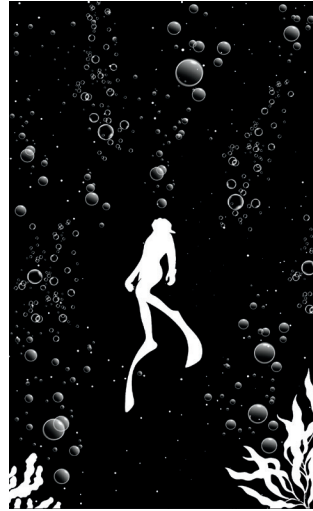

LA BANNIÈRE
FRONTALE EN MESH



LA BANNIÈRE ARRIÈRE +
BANNIÈRE MESH

- **Plafond "Ocean Layers"**

Code: **COL14**

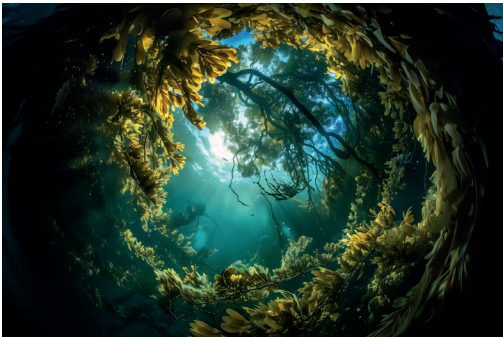

LA BANNIÈRE
ARRIÈRE

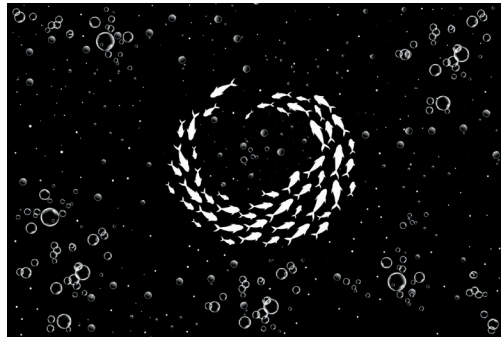

LA BANNIÈRE
FRONTALE EN MESH

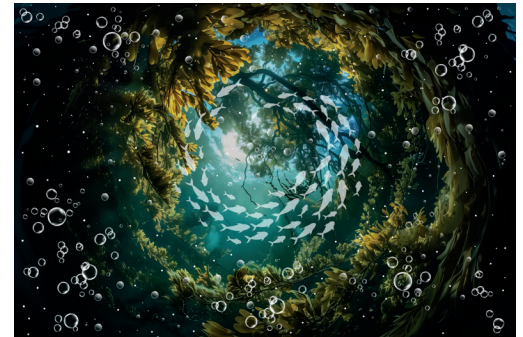

LA BANNIÈRE ARRIÈRE +
BANNIÈRE MESH

- **Plafond "Dance of the Rays"**

Code: **CDR15**



LA BANNIÈRE
ARRIÈRE



LA BANNIÈRE
FRONTALE EN MESH



LA BANNIÈRE ARRIÈRE +
BANNIÈRE MESH

OPTIONS D'INSPIRATION 3D

■ Mur "The Silent Bloom"

Code: **WSB16**

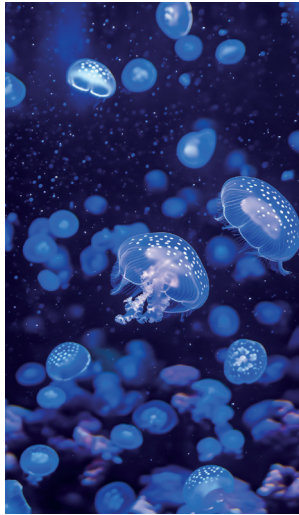

LA BANNIÈRE
ARRIÈRE



LA BANNIÈRE
FRONTALE EN MESH



LA BANNIÈRE ARRIÈRE +
BANNIÈRE MESH

■ Mur "The Hunter's Current"

Code: **WHC17**



LA BANNIÈRE
ARRIÈRE

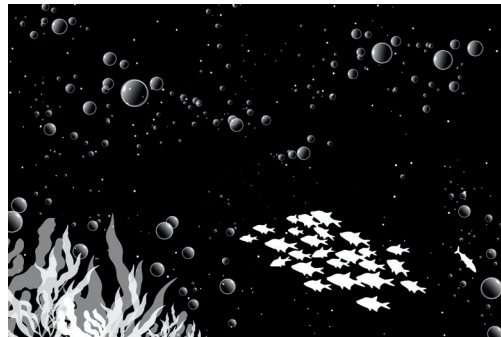

LA BANNIÈRE
FRONTALE EN MESH



LA BANNIÈRE ARRIÈRE +
BANNIÈRE MESH

■ Mur "The Ocean Floor"

Code: **WOF18**

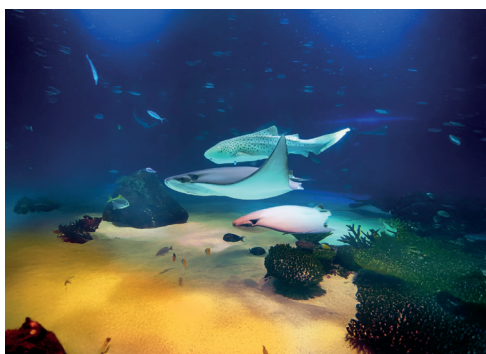

LA BANNIÈRE
ARRIÈRE



LA BANNIÈRE
FRONTALE EN MESH

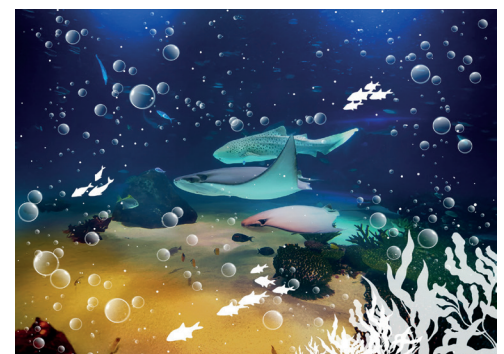

LA BANNIÈRE ARRIÈRE +
BANNIÈRE MESH

OPTIONS D'INSPIRATION 3D

■ Mur / Plafond "Amber Waves"

Code: **WCAW19**



LA BANNIÈRE
ARRIÈRE



LA BANNIÈRE
FRONTALE EN MESH



LA BANNIÈRE ARRIÈRE +
BANNIÈRE MESH

■ Mur / Plafond "Electric Flow"

Code: **WCEF20**

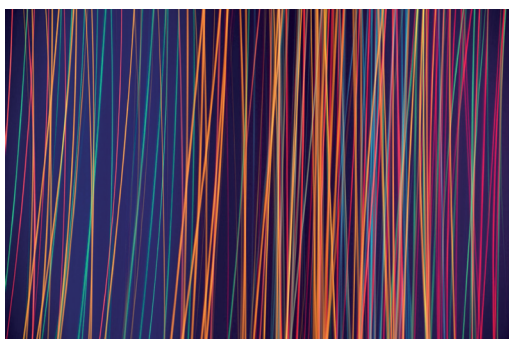

LA BANNIÈRE
ARRIÈRE

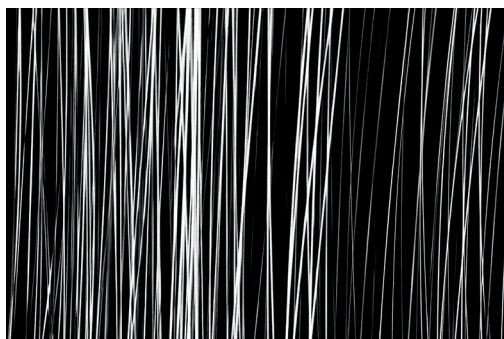

LA BANNIÈRE
FRONTALE EN MESH

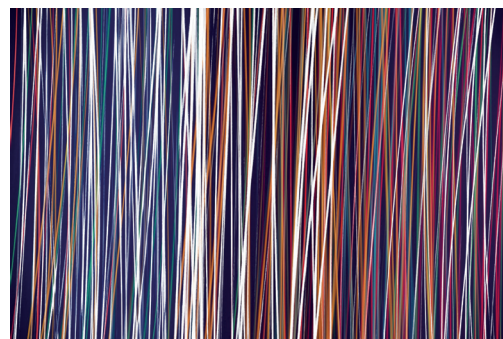

LA BANNIÈRE ARRIÈRE +
BANNIÈRE MESH

■ Mur / Plafond "Quantum Flow"

Code: **WCQF21**

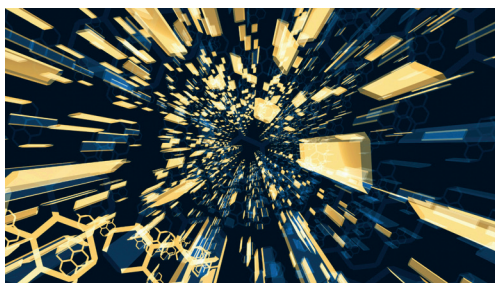

LA BANNIÈRE
ARRIÈRE

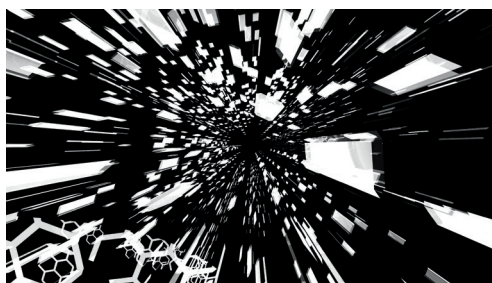

LA BANNIÈRE
FRONTALE EN MESH

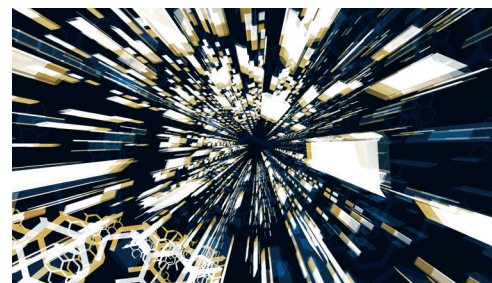

LA BANNIÈRE ARRIÈRE +
BANNIÈRE MESH

OPTIONS D'INSPIRATION 3D

■ Mur / Plafond "Waves of Light"

Code: **WCWL22**



LA BANNIÈRE
ARRIÈRE

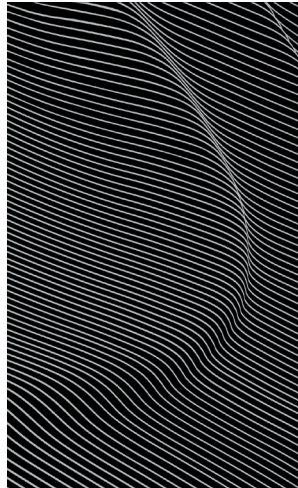

LA BANNIÈRE
FRONTALE EN MESH



LA BANNIÈRE ARRIÈRE +
BANNIÈRE MESH

■ Mur / Plafond "Orange Horizon"

Code: **WCOH23**



LA BANNIÈRE
ARRIÈRE

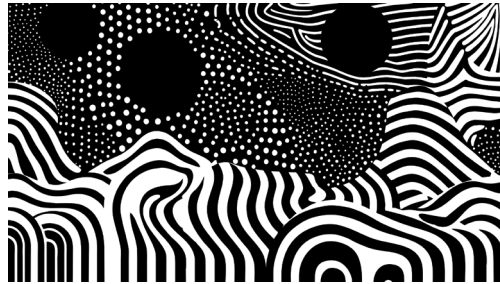

LA BANNIÈRE
FRONTALE EN MESH



LA BANNIÈRE ARRIÈRE +
BANNIÈRE MESH

■ Mur / Plafond "Neon Rain"

Code: **WCNR24**

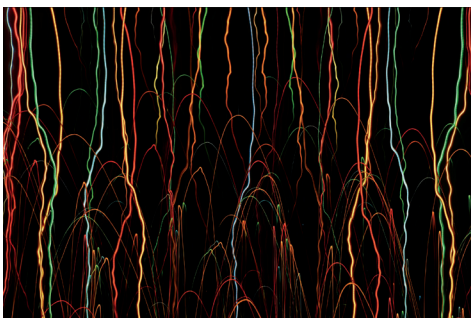

LA BANNIÈRE
ARRIÈRE

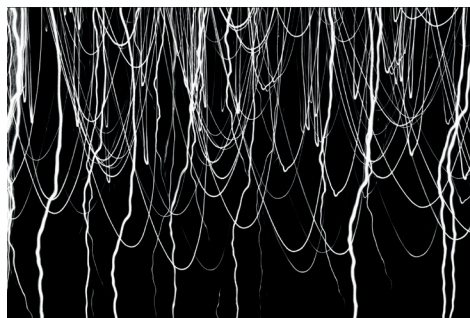

LA BANNIÈRE
FRONTALE EN MESH

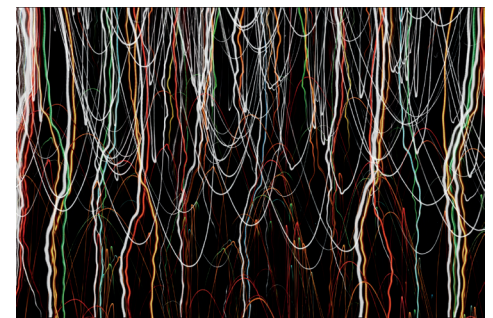

LA BANNIÈRE ARRIÈRE +
BANNIÈRE MESH

OPTIONS D'INSPIRATION 3D

■ Plafond "City of Light"

Code: **CCL25**



LA BANNIÈRE
ARRIÈRE



LA BANNIÈRE
FRONTALE EN MESH



LA BANNIÈRE ARRIÈRE +
BANNIÈRE MESH

■ Plafond "Urban Pulse"

Code: **CUP26**



LA BANNIÈRE
ARRIÈRE

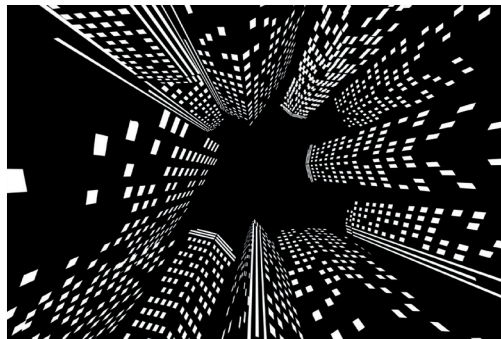

LA BANNIÈRE
FRONTALE EN MESH



LA BANNIÈRE ARRIÈRE +
BANNIÈRE MESH

■ Plafond "Metropolis Dream"

Code: **CMD27**



LA BANNIÈRE
ARRIÈRE



LA BANNIÈRE
FRONTALE EN MESH



LA BANNIÈRE ARRIÈRE +
BANNIÈRE MESH

OPTIONS D'INSPIRATION 3D

■ Mur "Nightfall Reflections"

Code: **WNR28**



LA BANNIÈRE
ARRIÈRE



LA BANNIÈRE
FRONTALE EN MESH



LA BANNIÈRE ARRIÈRE +
BANNIÈRE MESH

■ Mur "City of Mirrors"

Code: **WCM29**



LA BANNIÈRE
ARRIÈRE



LA BANNIÈRE
FRONTALE EN MESH



LA BANNIÈRE ARRIÈRE +
BANNIÈRE MESH

■ Mur "Urban Dreamscape"

Code: **WUD30**



LA BANNIÈRE
ARRIÈRE

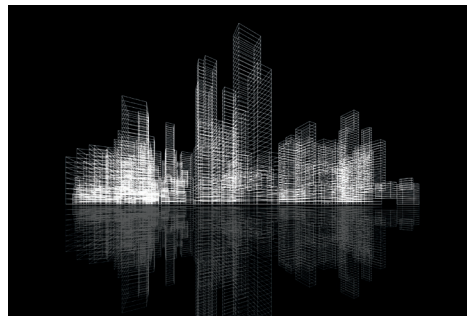

LA BANNIÈRE
FRONTALE EN MESH



LA BANNIÈRE ARRIÈRE +
BANNIÈRE MESH